

SHIRE

BUILT AROUND OUR REPUTATION



Completed 6 x 6 Double Door Apex Shed

Assembly of 6 x 6 Double Door Apex Shed ©

Thank you and congratulations on the purchase of your Shire Garden Building. We believe that this product will give you many years of excellent service. This is a natural product manufactured to a high standard therefore if you have any queries or experience any difficulties then please contact our customer service hotline **01945 46 89 10** or **01945 46 89 11** or **01945 46 89 12**.

Preparation of Base

We recommend that the base onto which your building will stand should be at least 75mm larger in each direction than the total floor size of the building.

Actual floor area of the building: 1790 x 1790mm

Total height clearance: 2280mm

The chosen position in your garden for the siting of the building should be excavated to a depth of 75mm to allow a base of sand, on to which paving slabs can be evenly laid - **THEY MUST BE LEVEL AND FIRM.**

Treatment/Care of your Garden Building

Treat with a suitable decorative wood finish immediately. We recommend that all timber pieces be treated again prior to assembly and again within 3 months of assembly. We further recommend that all pieces are treated again at least annually or as frequently as the instructions on the product used recommends.

We would suggest that all wall panels be treated in an upside-down position to allow the finish/treatment to ingress into the tongue and groove jointing.

We would also remind you that you would rarely (if ever) be able to re-treat the underside of the floor following assembly. We strongly recommend that the underside of the floor is treated an absolute minimum of twice (not including pre-treatment).

Tools Required

- Posidrive screwdriver (electric is best)
- Drill, 6mm drill bit, 8mm drill bit
- Hammer
- Sandpaper (to smooth any rough edges)
- Cutting knife
- Tape measure
- Step ladder
- Ruler
- Pencil
- Saw

IMPORTANT!

PLEASE READ PRIOR TO ASSEMBLY OF THE BUILDING

EVERY PRECAUTION IS TAKEN TO ENSURE THAT YOUR BUILDING HAS NO ELEMENT INCORRECTLY PLACED OR POSSIBLY HAZARDOUS, HOWEVER PRIOR TO USE PLEASE CHECK ALL SURFACES FOR THE FOLLOWING:

- 1 RAISED GRAIN, SPLINTERS: sand down timber to smooth finish
- 2 NAIL/SCREW/PIN HEADS PROUD: tap home to be flush with surface of timber
- 3 DAMAGED SCREW HEADS RESULTING IN SHARP SPLINTERS OF METAL: replace
- 4 SHARP ENDS OF NAILS/ SCREWS/ PINS PROTRUDING THROUGH THE PANEL: remove and reposition.
- 5 ENSURE ALL PARTS ARE SECURED AGAINST REASONABLE FORCE: remove and refit
- 6 ENSURE THERE ARE NO LOOSE PARTS: remove and refit/discard

We recommend that protective gloves be worn throughout

PLEASE NOTE

Wood is a natural product and is therefore prone to changes in appearance, including some warping, movement and splitting, particularly during unusual climatic conditions (long hot or wet spells of weather). As a natural occurrence this is not covered by a guarantee.

Parts List

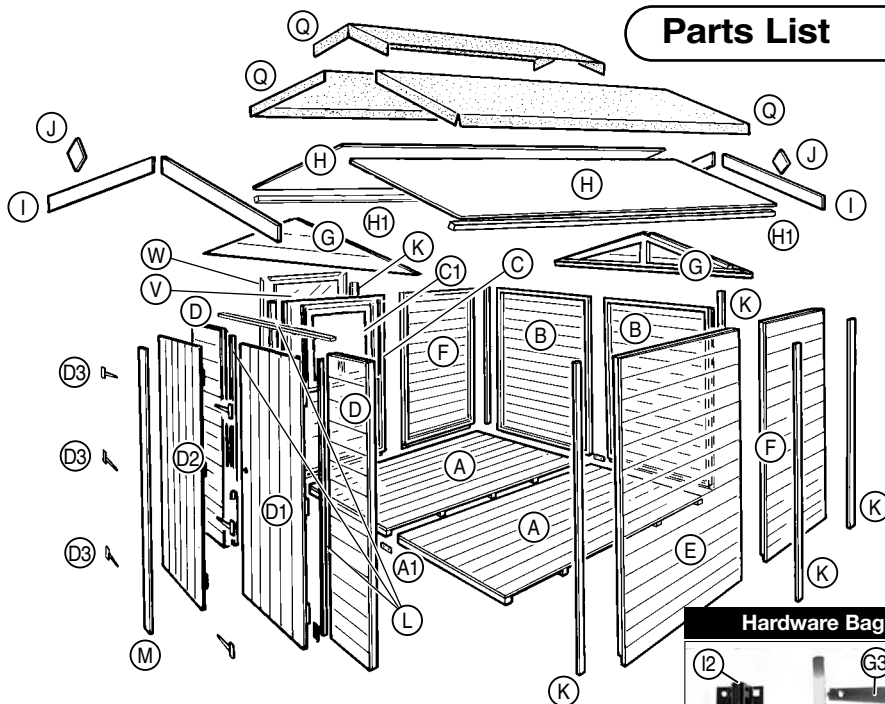

PLEASE LAY OUT PARTS AND CHECK OFF AGAINST CHECK LIST BELOW:

QTY DESCRIPTION

QTY	DESCRIPTION	
14	Timber sections	A x2, B x2, C x1, D x2, E x1, F x2, G x2
1	Window frame	C1
2	Doors	D1, D2
1	Large door stop strip	M
3	Small door stop strips	L
2	OSB roof sections	H
4	Roof bearers	H1
1	Piece felt 1m wide x 4m long	Q
1	Piece felt 0.5m x 2m long	Q
7	Cover strips	K
4	Facia boards	I
2	Diamonds	J
1	Pane glazing material	V
4	Pieces glazing beading	W

Hardware Bag Contents

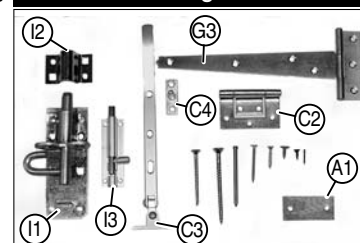

QTY DESCRIPTION

QTY	DESCRIPTION	
2	Metal plates	A1
1	Padbolt + housing	I + I2
2	Small bolts	I3
6	Door hinges	D3
2	Window hinges	C2
1	Casement stay	C3
2	Casement stay pins	C4
77	25mm screws	
30	60mm screws	
101	40mm nails	
8	10mm screws	
3	60mm nails	
96	Felt nails	
8	15mm panel pins	

A - Fit Window Insert C1 (from top)

1 Place one hinge 'C2' on the inner rebate part of the top of the window 'C1'. The rounded part of the hinge should sit above the outer edge of the window. Screw the inner piece into position using the pre drilled holes in the hinge and 2 x 25mm screws. Repeat.



2 Place the window into the aperture. Secure the window to the panel using 3 x 25mm screws per hinge, again through the predrilled holes in the hinge. Repeat.



3 Open the window and fit a further 2 x 25mm screws per hinge next to the one already fitted in Step 1. Repeat.



4 Fitting the Casement Stay 'C3'. Place the casement stay centrally on the inside of the window. Place the 2 pins 'C4' under the casement stay. Position so that it is not resting on the framework of the panel and not so high that the pins are of no use.

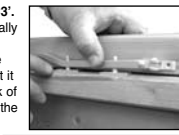

5 Fit the Casement Stay on the window using 2 x 25mm screws.



6 Mark where the 'pins' will be placed.



7 Secure into position using 4 x 25mm screws - 2 in each pin.



B - Floor and Wall Assembly

PLEASE NOTE: Use the 6mm drill bit for this section of the assembly.

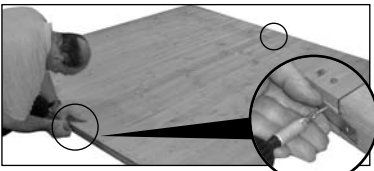

1 Lay both sections of floor 'A' on a flat base with the floor joists to the front (where the doors will be fitted). Ensure floor is level. Join together front and back with two metal plates using 2 x 25mm screws per plate.

2 There are 8 wall panels in 4 different sizes. The 2 pieces that measure 895mm 'B' are to go at the back - opposite the door. The floor joists run from side to side. The solid edge of the joist is therefore at the front/back. Each side wall is made up of 1 wall measuring 1160mm 'C' & 'E' and 1 wall measuring 560mm 'F'. One of the 1160 mm 'C' & 'E' walls has a window. The door end is made up of 2 small 215 mm 'D' pieces and the doors. The window panel may be positioned at either side and either end to suit your requirement.



3 Place one side panel at one back corner. Place a back panel inside the panel already in place. Ensure the bottom edge of cladding has overhanging the floor. Drill 2 holes, one to the top and one to the bottom. Do not drill into the adjacent panels. Secure the panels together using 2 x 60mm screws. Repeat for all wall panels.

C - Gable Assembly

1 Position gable panel 'G' into position ensuring that the gable is positioned evenly and flush along the top edge of the panel. Drill 4 holes from under the wall bearers, 2 either side of the centre upright. Do not drill into the gable panel. Repeat with other gable.



2 Secure into position using 4 x 60mm screws. Repeat with other gable.



D - Roof Assembly

1 Place 2 pieces of framework 'H1' onto a flat level surface. Place 1 roof panel 'H' on top of the framework ensuring it lays flush against the outside edges of the framework and secure using 6 x 40mm nails on either side. Repeat for other roof panel.

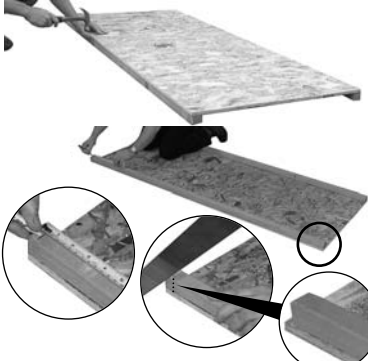

2 Measure 12mm from either end of the roof bearers which will be positioned at the peaks only when placed. Cut out marked sections on the roof bearer using a saw. Cut through the roof bearer only. Note the cut-outs are to be made on the gable peak edge only for each roof panel.

3 Repeat process for other roof panel.

4 Place both roof panels into position using the cut-outs. Both pieces should be level with each other and positioned centrally on the walls.

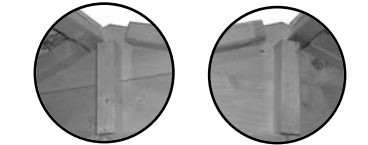

5 Nail the two ridge pieces together from inside the building using 3 x 60mm nails equally spaced along the length of the ridge.



6 Nail through each roof section 'H' and into the walls using 3 x 40mm nails for each short section and 5 on each long section, 22 in total.

E - Door Assembly

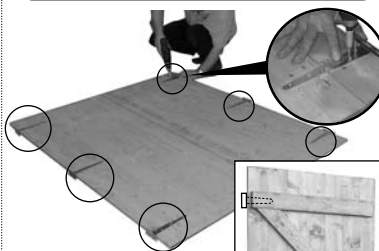

1 Place the doors on a flat level surface outside door edge up as they would fit when actually assembled.

Ensure which side you fix the hinges is correct i.e. the reverse side diagonal door bearers meet towards the centre of the door opening (see diagram)

Fit the hinges 'D3' to both doors 'D1' and 'D2' ensuring they are directly on the horizontal bearers on the opposite side of the door. Secure using 4 x 25mm screws per hinge.

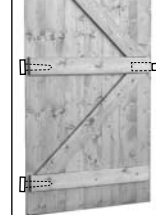

Inside of door - for positions in relation to bearers. **DO NOT FIT HINGES & LOCKS ON INSIDE**

Each hinge consists of three parts - a long pointed part, a round movable part and a flat rectangular part. The long pointed part should be fitted to the door with the end of this part finishing at the end of the door. The round removable part will be overhanging the edge of the door.



2 To hang the doors two people are needed - one person to hold the door square and level and the other person to attach hinges onto panels 'D'. Start with the right hand door D1. The flat rectangle part of the hinge is fitted to panel D. This should be fitted so that half of the round movable part of the hinge is against panel D and half is overhanging the edge of this panel. This will leave a gap of 1-2mm between the edge of the panel and the edge of the door. Screw into position using 3 x 25mm screws per hinge. Repeat with door D2.

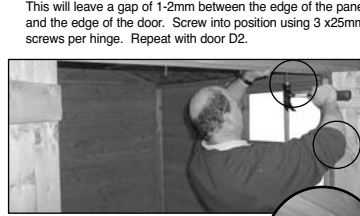

3 Fit small door stop strips - pieces L. Fit flush to the inside edge of panels D and top horizontal beam and nail into position using 18 x 40mm nails, 6 for each piece.

4 Fit two bolts to the inside, inner edge of the left door D2. The top bolt should be positioned so that the solid part of the bolt finishes flush with the top of the door. Fit using 4 x 10mm screws. Hold the door tightly closed. The door stop strip may have to be cut to allow this. If so, hold the door closed and mark where the bolt touches the door stop strip (approx 15mm) and cut this piece out. Move the movable part of the bolt and mark where this meets the door frame. Drill a small hole using a 8mm drill bit.



The bottom bolt should fit flush with the bottom edge of the door and a hole will also need to be drilled into which the movable part of the bolt will fit. Fit the bolt using 4 x 10mm screws. Extend the movable part and draw around this part. This is where a hole should be drilled.

5 Place the padbolt in position on the outside of the right hand door, directly over the central horizontal bearer, ensuring the edge is flush with the upright edge. Secure using 4 x 25mm screws using the round holes only.



6 Place padbolt housing in position to accommodate padbolt and secure using 2 x 25mm screws using round holes only.



7 Place outside door cover strip flush with top and bottom of the door and mark top and bottom of padbolt position.

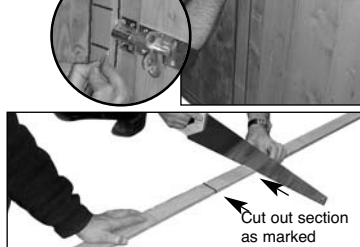

8 Attach the door stop strips above and below the padbolt. This should be fitted to the outside, inner edge of the right hand door D1. Half of the strips should overhang the edge of the door so that when the door is closed it will overhang door D2 as a result it covers the natural gap between the two doors. Use 5 x 25mm screws.



F - Cover Strips

1 Nail cover strips 'K' at each corner and over each panel joint. Use 3 x 40mm nails per strip.



G - Felt, Facia & Diamond Assembly

1 Two rolls of felt 'Q' have been supplied. One roll is 1m wide x 4m long and one roll is 500mm wide x 2m long. Lay the 4m roll onto an even, clean surface and cut in half to produce 2 pieces that measure 1 mtr wide x 2m long.

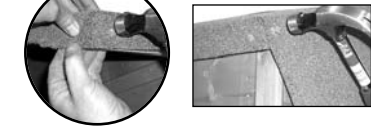

2 Starting at the lower edge (the eaves) place one 1 mtr wide piece from the front to the back of the building. An overhang of approximately 45mm should be allowed on each of the 3 sides although the felt will overhang at the back by more than this. Secure the felt using felt nails spaced at 100mm intervals. Repeat, but do not nail along the centre of the building until the piece of felt covering the ridge is in place.

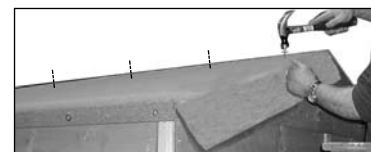

3 Place the smallest piece of felt at the peak (ridge) of the building. This piece will overlap both of the other pieces of felt. Nail into position along both edges of this piece and at both ends.

4 Nail facia boards 'I' into position using 3 x 40mm nails per facia board. Repeat for opposite gable end.



5 Carefully trim off excess felt with cutting knife against the edge of the facia board.



6 Nail diamond 'J' into position ensuring it is vertical using 2 x 40mm nails. Repeat for opposite gable end.



H - Placing Glass in Window Frame

1 Place the glazing material 'V' in the window aperture of the window frame.



2 Place four strips of beading 'W' around the edge and nail into position using 2 x 15mm panel pins per piece of beading. Fit the short beading first. The long beading may need to be bent and allowed to 'ping' into place. It may well be a tight fit.



I - Securing Walls to Floor

1 Screw all wall panels to the floor on the inside of the building using 1 x 60mm screw per separate panel, preferably into the floor joist.



Assembly Completion Checklist

1 Check and ensure that no raised grain or splinters are evident on timber components. Sand down any raised grain or splinters using fine grade sandpaper.

2 Check that all screw, nail and pin heads are properly tapped home and are not proud of the timber surface.

3 Check and ensure that no screws, nails or pins protrude through any panel.

4 Check and ensure that all parts are properly secured against reasonable force.

5 Do not apply decorative wood finish/treatments to wet or damp timber. Please observe the instructions of the wood finish/treatment manufacturer.