

Assembly Instructions

Before assembly

- We recommend that time is taken to read the instructions before starting assembly, then follow the easy step by step guide. The instruction sheet is only a guide to the assembly. Certain items may not be shown to scale.
- Check all components prior to assembly
- This product should be assembled by no less than 2 people.
- Never attempt to erect the assembly in high winds.
- It may be necessary to drill pilot holes for screws.



Recommended tools for assembly

- Cross head screw driver
- Drill with 4mm diameter drill bit
- Spirit level
- Step ladder

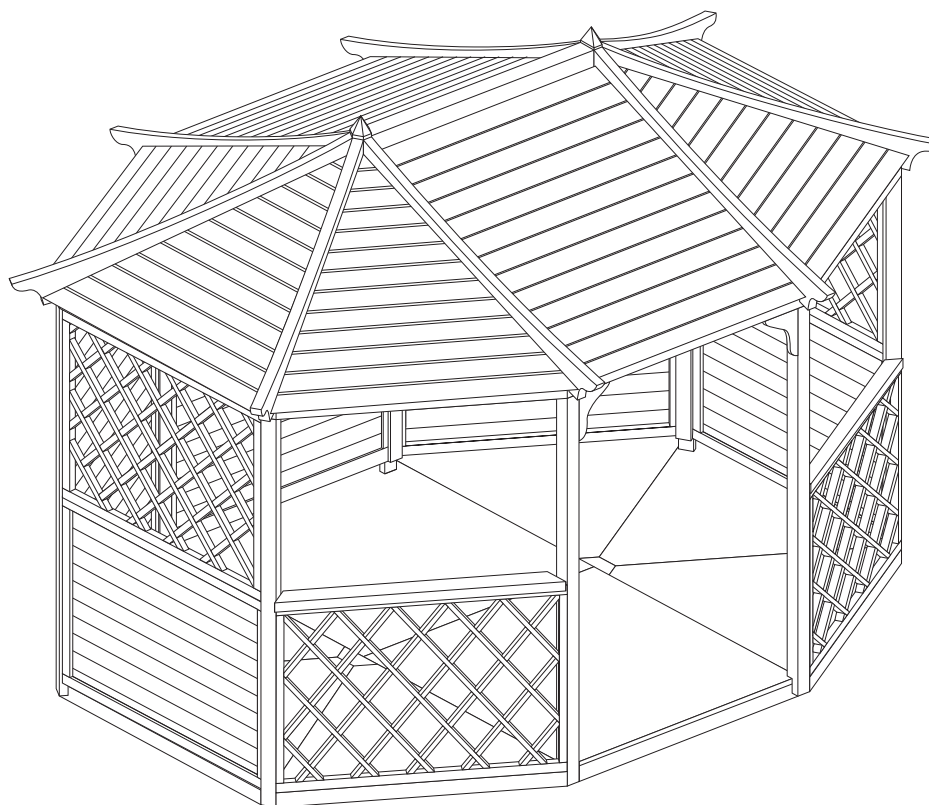

We constantly improve the quality of our products, occasionally the components may differ from the components shown and are only correct at time of printing. We reserve the right to change the specification of our products without prior notice.

1

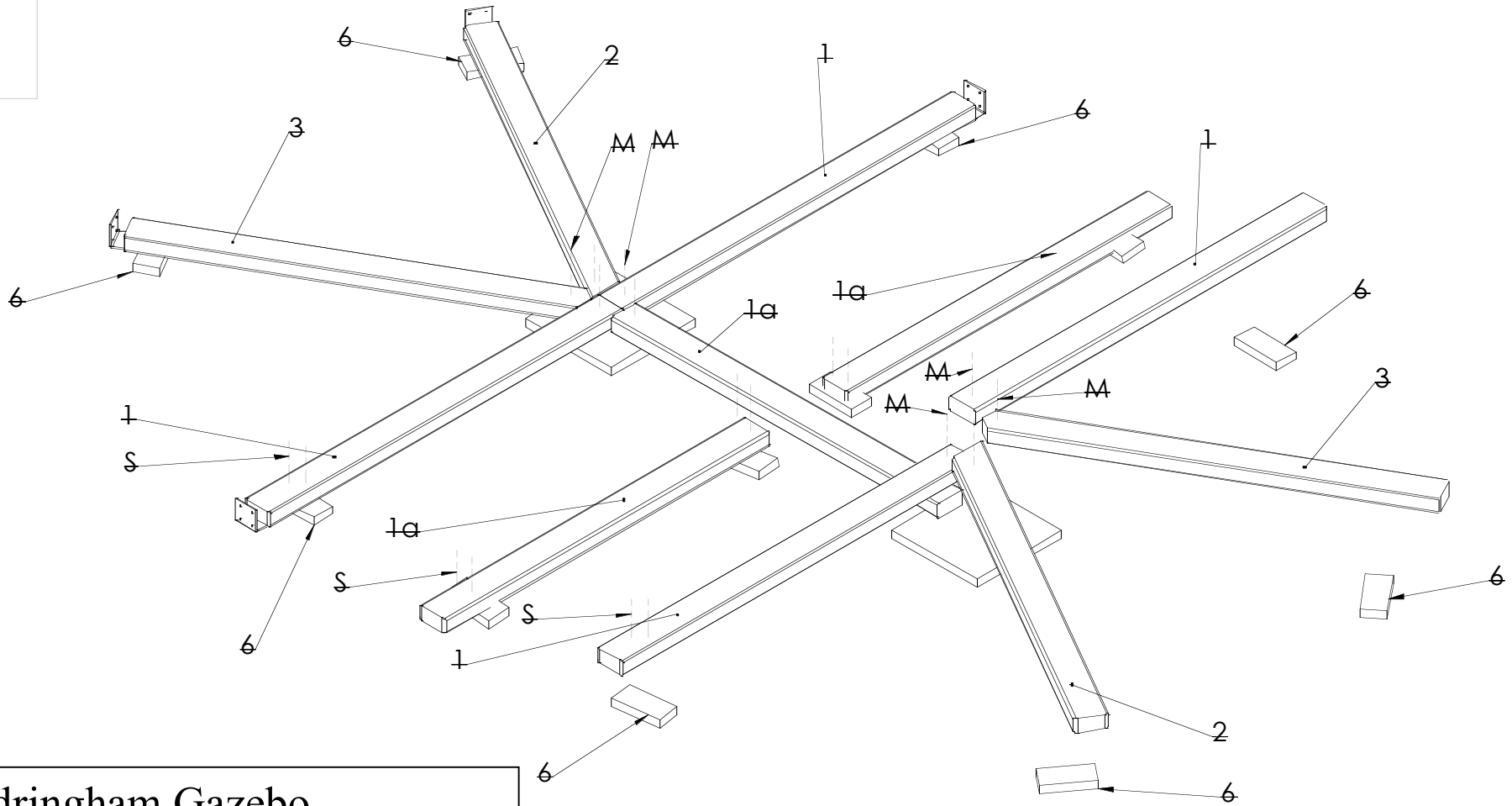

Sandringham Gazebo

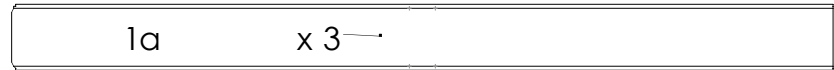
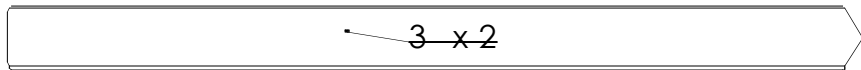
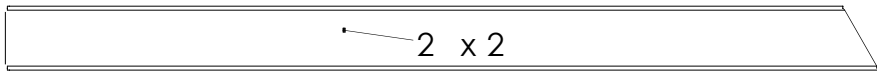
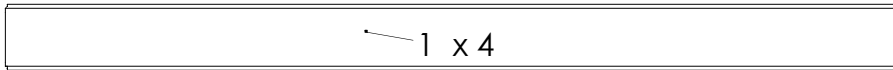

6 x 12

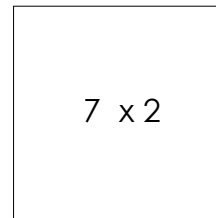

7 x 2

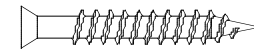

S 4x50 x 24

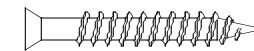

M 4x70 x 10

2

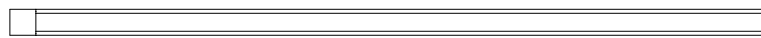
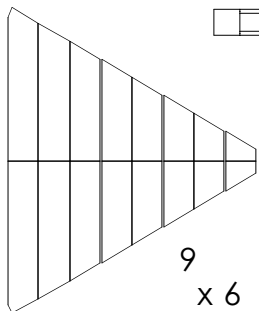
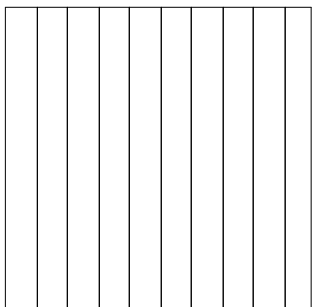
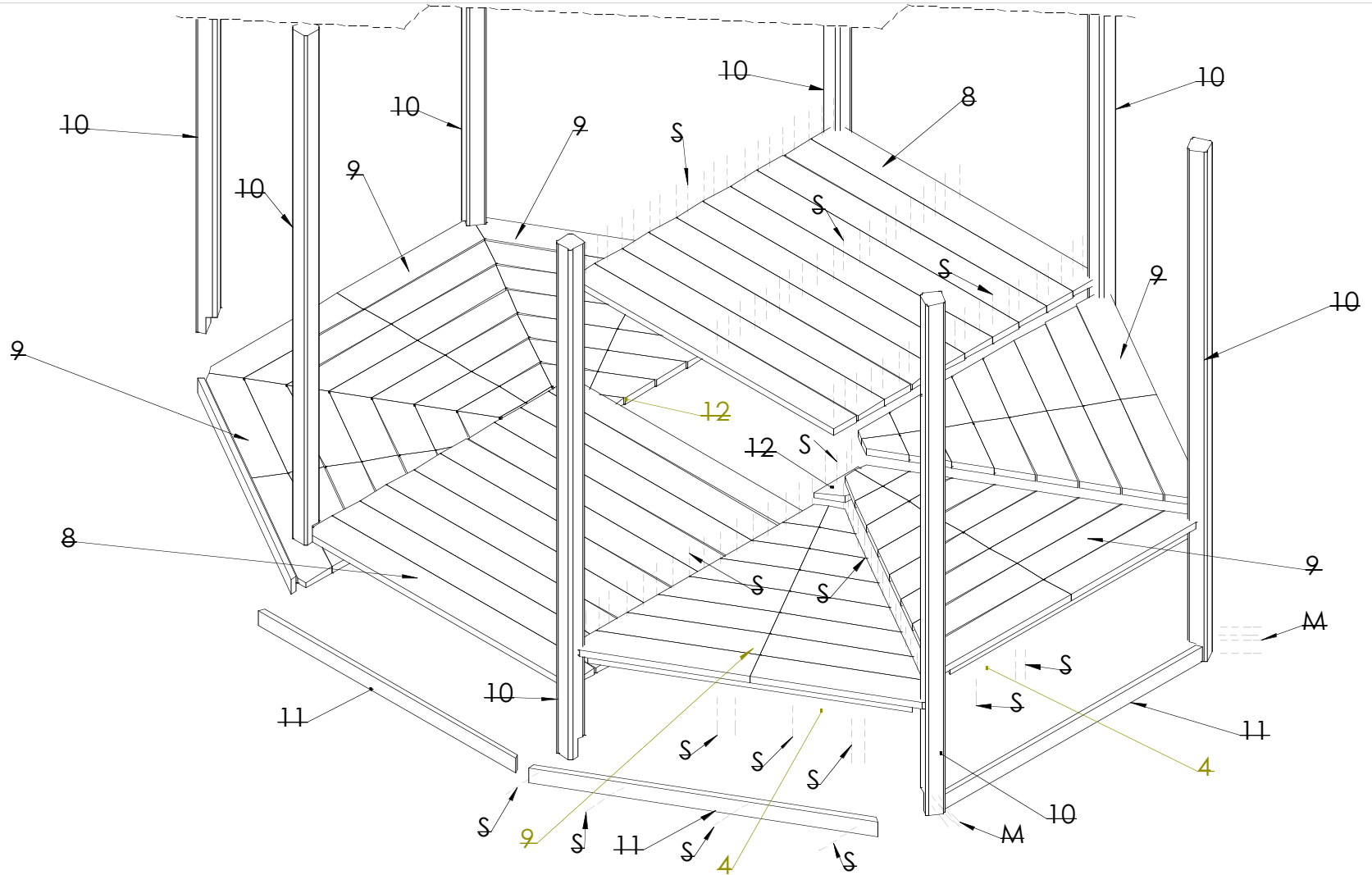

10 x 8



11 x 8



12 x 2



4 x 6

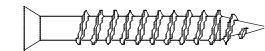

S 4x50 x 352

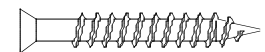

M 4x70 x 62

3

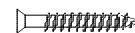
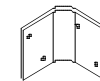
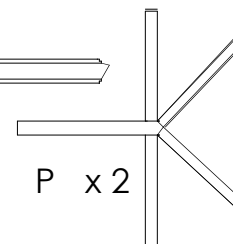
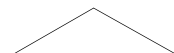
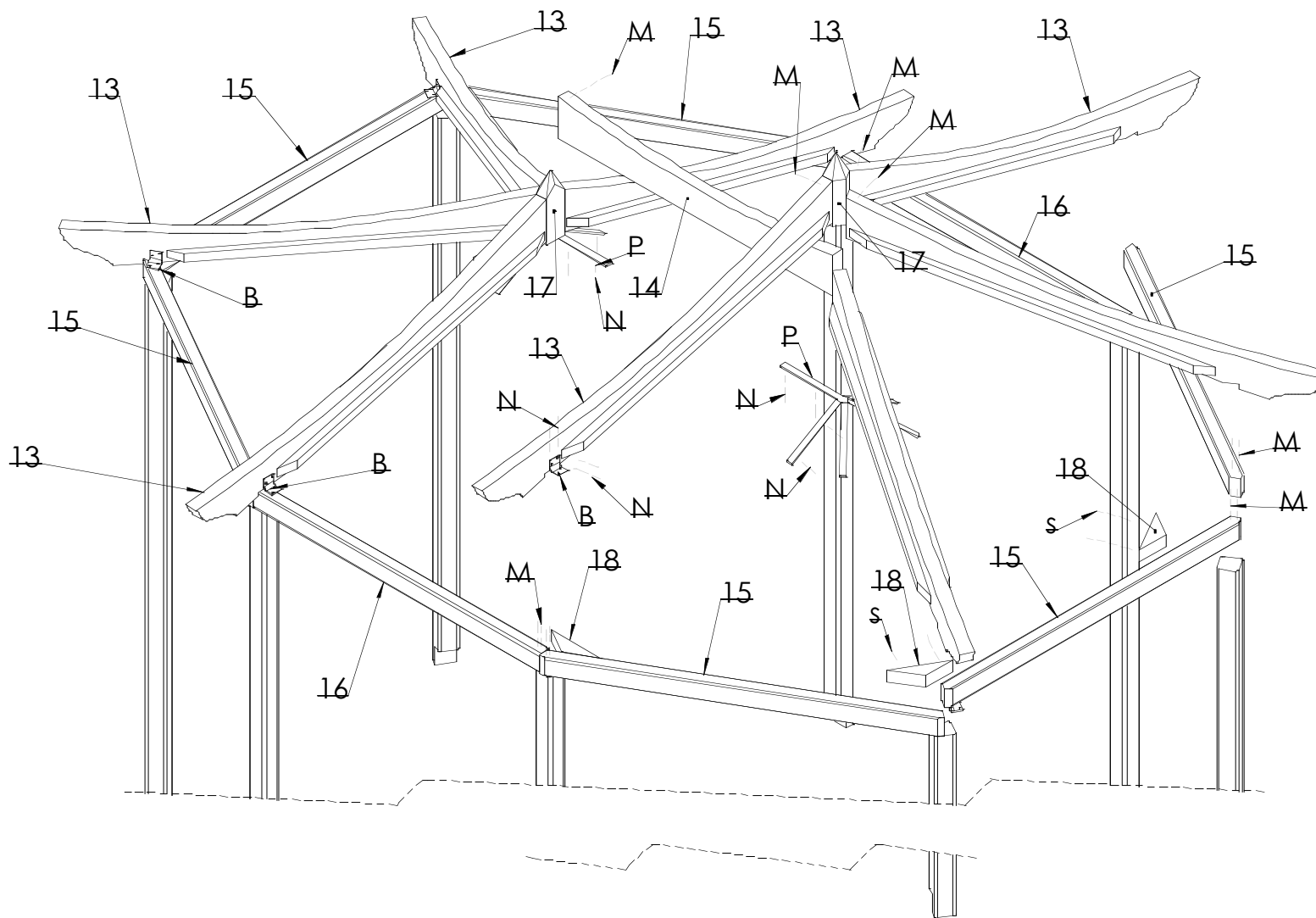

S 4x50 x 16

M 4x70 x 42

4

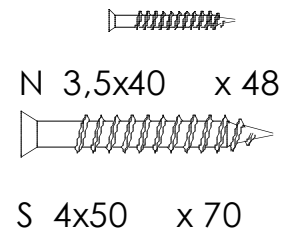
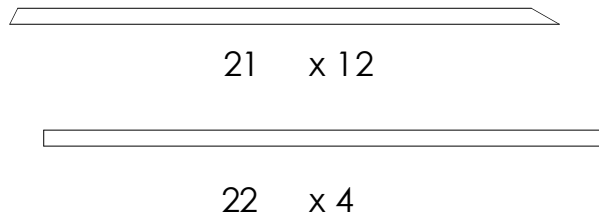
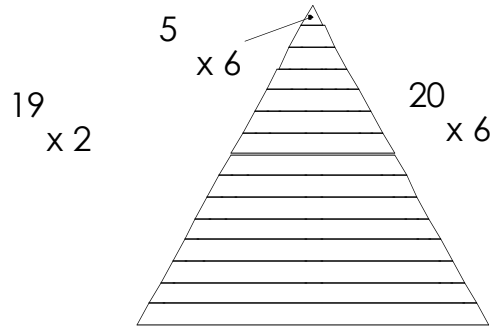
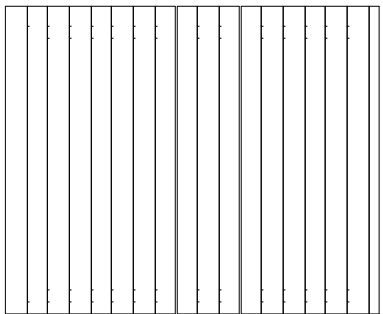
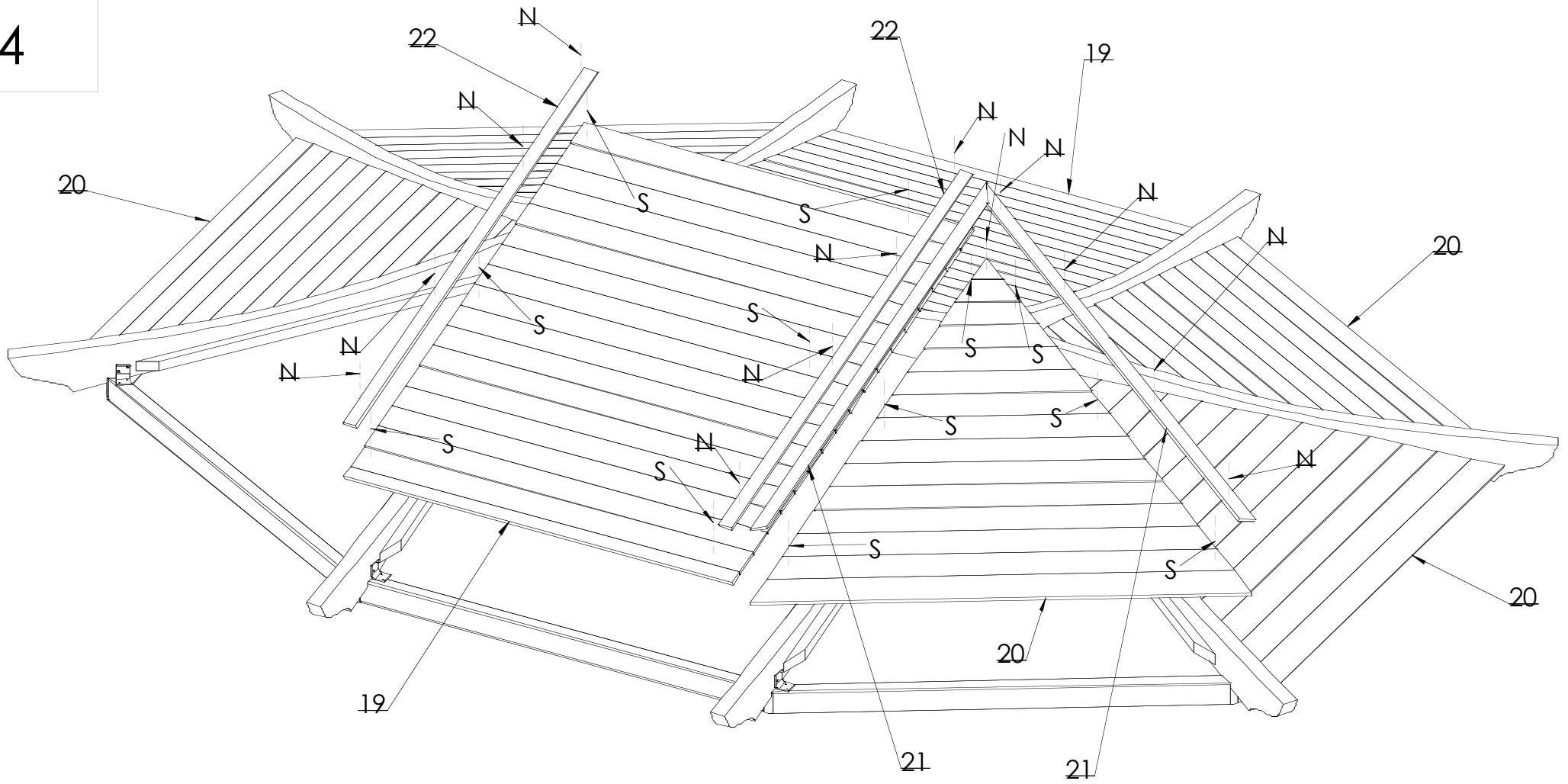

5

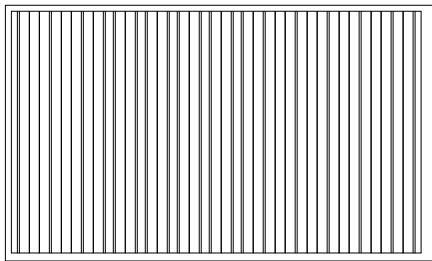
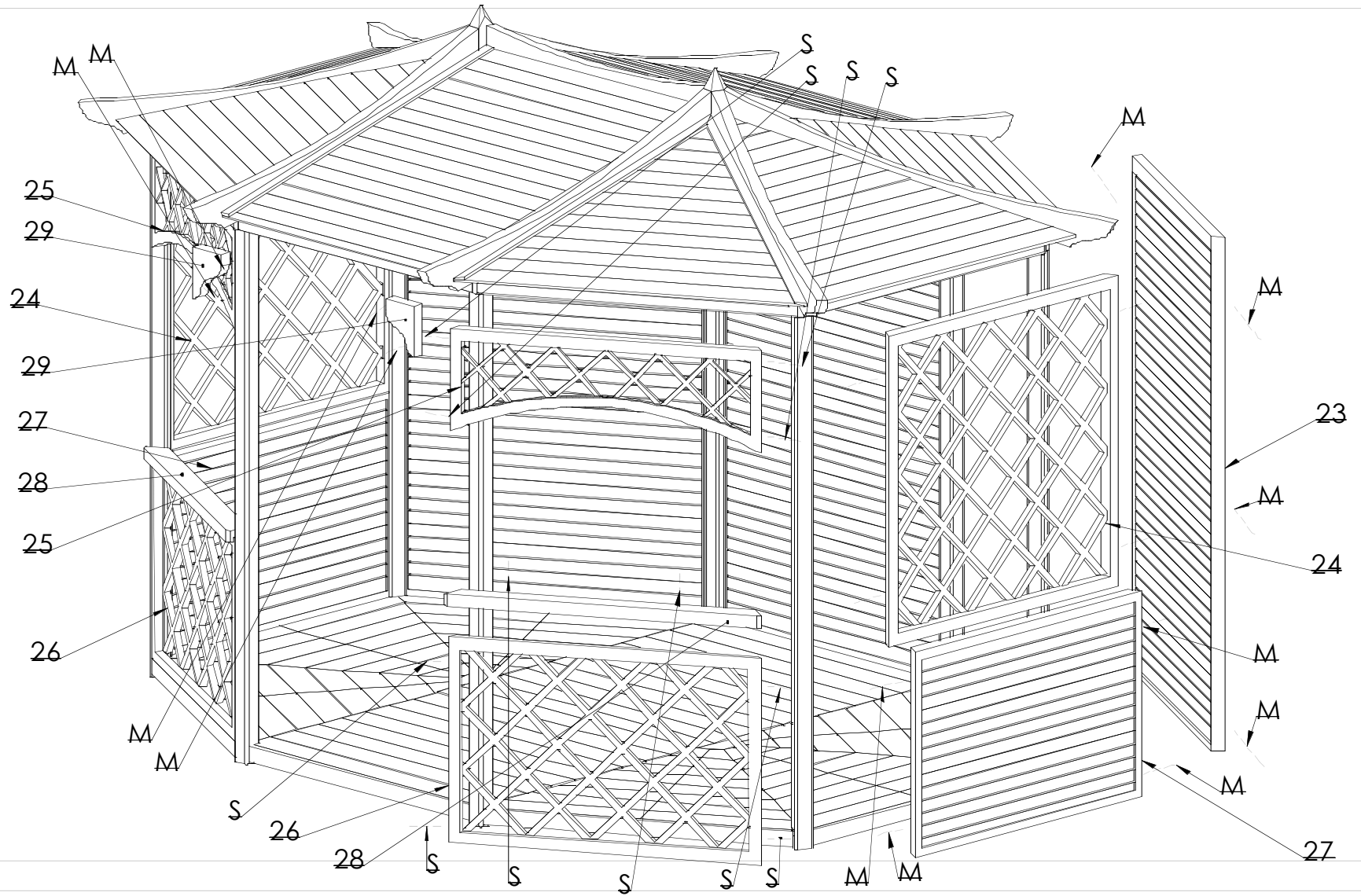

23 x 3

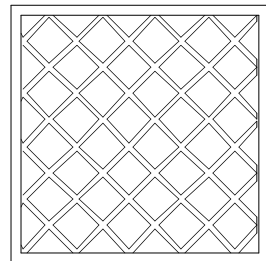

24 x 2

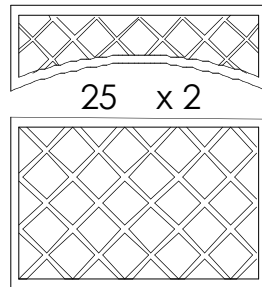

25 x 2

26 x 2

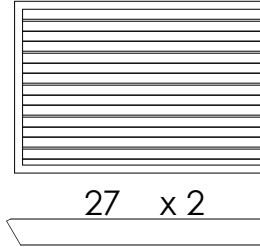

27 x 2

28 x 2

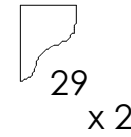

29 x 2

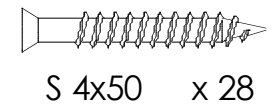

S 4x50 x 28

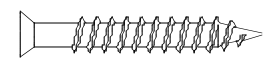

M 4x70 x 30