

Before assembly

- We recommend that time is taken to read the instructions before starting assembly, then follow the easy step by step guide. The instruction sheet is only a guide to the assembly. Certain items may not be shown to scale.
- Check all components prior to assembly
- This product should be assembled by no less than 2 people.
- Some of the components may have sharp edges wear protective work gloves while handling components.
- Never attempt to erect the assembly in high winds.
- Drill components where indicated.



Recommended tools for assembly

- Cross head screw driver
- Hammer
- Sharp knife
- Hacksaw
- Drill
- 4mm diameter drill bit
- 12mm diameter drill bit
- Spirit level
- Silicon sealant
- Step ladder

No.	Components	Qty.
1	Floor sections	2
2	Back and side panels	6
3	Front panels	2
4	Left door	1
5	Right door	1
6	Apex panels	2
7	Front right roof section	1
8	Front left roof section	1
9	Middle/rear roofs sections	4
10	Roof purlin (36 x 29 x 2050mm)	4
11	Coverstrip (48 x 12 x 1690mm)	7
12	Kick strip (38 x 12 x 1360mm)	1
13	Lattice wing panels	2
14	Door glazing (372 x 264mm)	12
15	Window glazing (190 x 370mm)	6
16	Door beading (375mm)	24
17	Door beading (236mm)	24
18	Window beading (165mm)	12
19	Window beading (375mm)	12
20	Roof felt roll (5m)	1
21	Roof ridge felt roll (2.5m)	1
22	Barge boards (48 x 12 x 1150mm)	4
23	Apex cover (110 x 12 x 1990mm)	1
24	Door frame beading (15 x 15 x 100mm)	1

No.	Fixing Kit	Qty.
25	Finials	2
26	Latch Door handle kit	1
27	Door Hinges	6
28	Tower bolts	2
29	60mm screws	2
30	50mm screws	39
31	35mm screws	6
32	25mm screws	30
33	19mm round head screws	8
34	19mm black round head screws	10
35	60mm nails	8
36	40mm nails	77
37	25mm nails	219
38	10mm felt nails	148

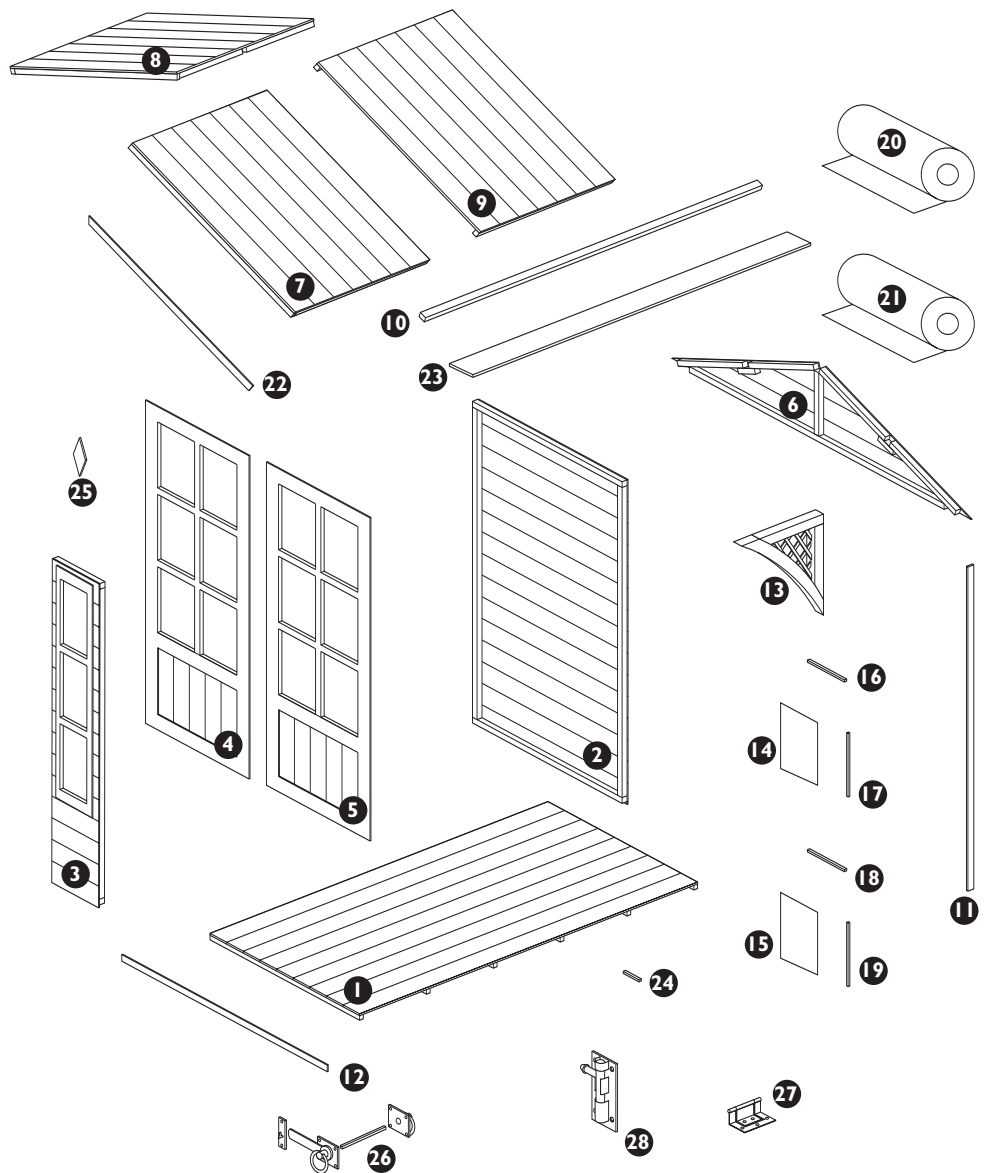
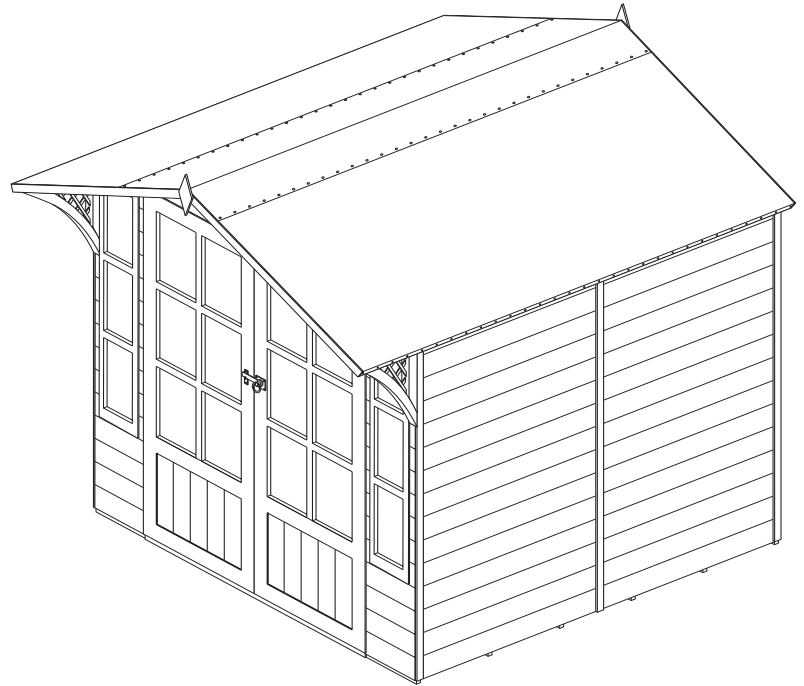

1. Laying the floor sections

Prepare a level area for the summerhouse to sit. Attach 3 wooden or similar bearers of size 75 x 50 x 2040mm to each of the floor sections (not supplied in kit). Place the 2 sections on the floor butted up next to each other, as shown in the diagram.

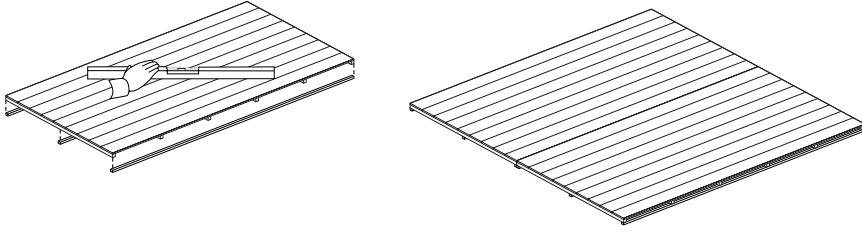

To "VALIDATE" the guarantee, this item should be erected on 75mm x 50mm treated wooden or similar bearers (**These are not supplied with the kit.**) Ground contact must be avoided.

2. Fixing the wall panels together

Position 1 back panel and 1 side panel on the floor as shown. Note how the panel frames sit on the floor with the panel cladding overhanging the floor edge. Ensure square, secure the 2 panels together using 3 x 50mm screws. Screw through the frame of the side panel into the frame of the back panel. Position the other back panel next to the first, ensure level and secure them together using 3 x 50mm screws through the frame of the first panel into the frame of the second. Continue adding the rest of the panels as shown in the diagrams.



It is recommended to drill pilot holes for these screws with a 4mm drill bit before assembly.

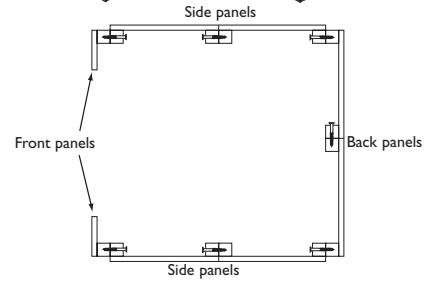
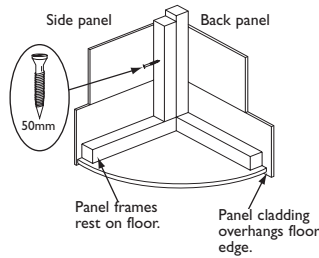
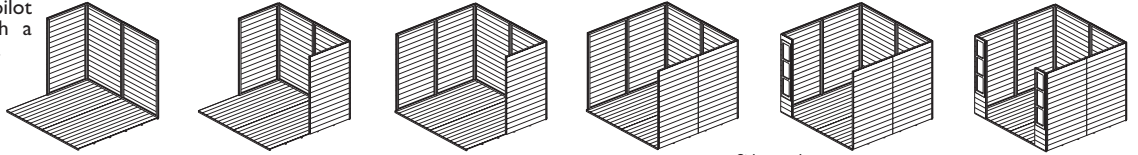
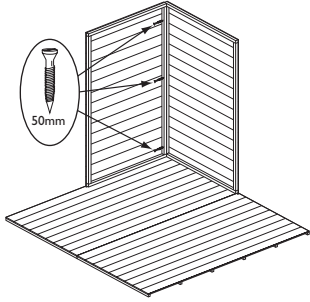

3. Attaching apex panels and

Place the back apex panel on top of the back panel, make sure the bottom Shiplap board of the apex panel fits correctly into the Shiplap board of the back panel. Secure by using 2 x 50mm screws, screw up through the top frame of the back panel into the bottom frame of the apex panel. Repeat for front apex using 60mm screws. Attach to the front apex the door frame beading using 3 x 25mm nails. Secure it to the bottom of the framing, up against the cladding about 560mm from the right front panel as shown below.

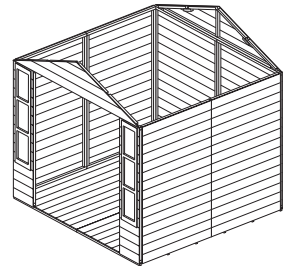
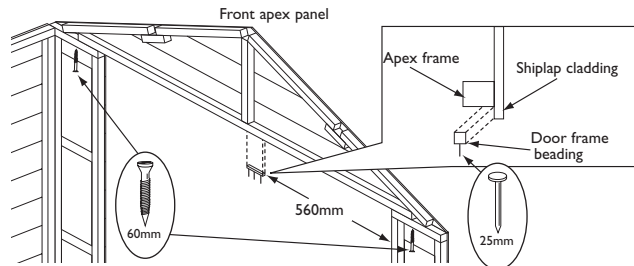
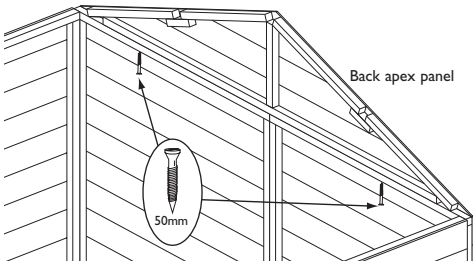

4. Securing the walls to the floor

Ensure the panels are sitting square on the floor. Secure them by nailing through the panel frames into the floor using 8 x 60mm nails.

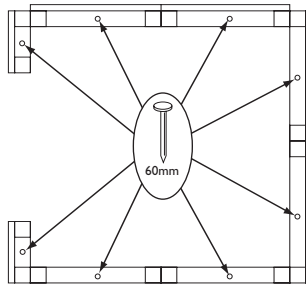
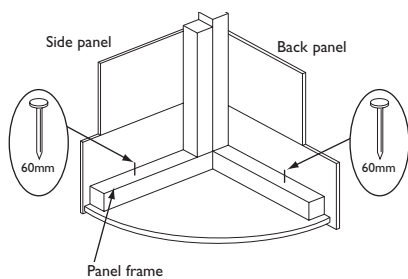

5. Roof purlins

Insert the 4 roof purlin into the rebates in the apex sections. Fix in place at the ends of the purlin, using 2 x 50mm screws per purlin. Screw through the purlin and into the frame of the apex panels.



It is recommended to drill pilot holes for these screws with a 4mm drill bit before assembly.

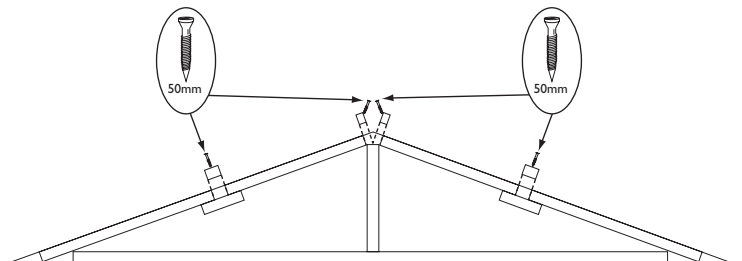
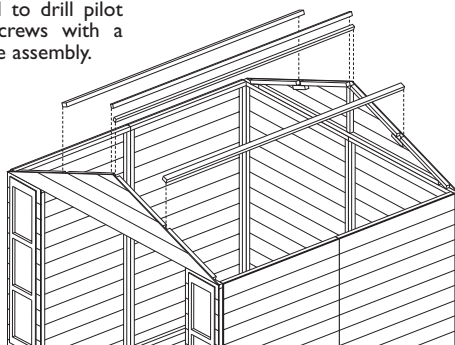

6. Attaching roof sections

Lift a roof panel onto the roof and hook it over the upper roof purlin, ensure it is flush with the back of the building and secure down using 6 x 40mm nails, secure to the 2 roof purlin and to the top frame work of the side panel. Hook the middle panel over the upper purlin and with it pushed right up against the first panel secure in the same way. Repeat for the third panel, Make sure this panel has the felt batten at the front. Fit the 3 roof panels for the other side of the roof in the same way. To the inside of the roof fit the apex cover to the 2 centre purlin using 6 x 35mm screws.

Side view of roof panel

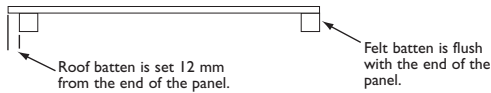

Important
Make sure the 2 roof panels at the door end have front felt battens.

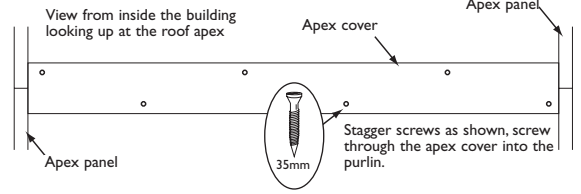
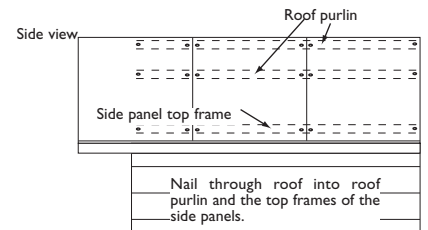
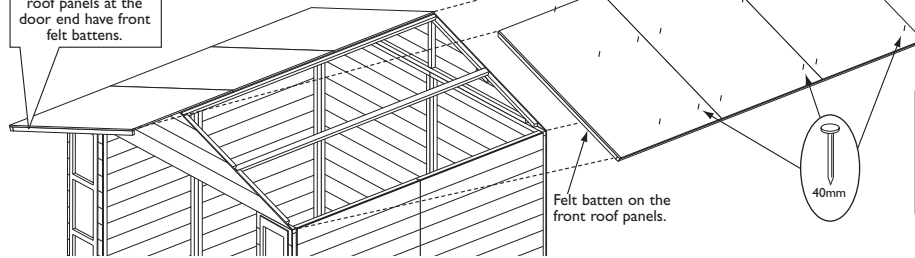

7. Roofing felt

Cut the 5m roofing felt roll into 2 equal lengths. Place a length over half of the roof. At the front and along the lower edge of the roof leave an overhang of felt of at least 45mm. Fold down the felt along the lower edge and secure to the felt batten using 30 x 10mm felt nails evenly spaced. Tension the felt over the roof and secure along the upper edge using 6 x 10mm felt nails. Repeat this for the second piece of felt on the other half of the roof. Once the 2 pieces of felt are in place take the 2.5m ridge felt roll and place over the apex of the roof making sure it sits centrally over the roof ridge and overlaps the other 2 felt pieces, attach using 30 x 10mm felt nails evenly spaced, along the 2 long edges of the ridge felt. Dress down the ends of the felt and at the front attach to the felt batten with 6 x 10mm felt nails. Repeat at the back but attach the felt to the apex panel. Once secured trim off excess felt.

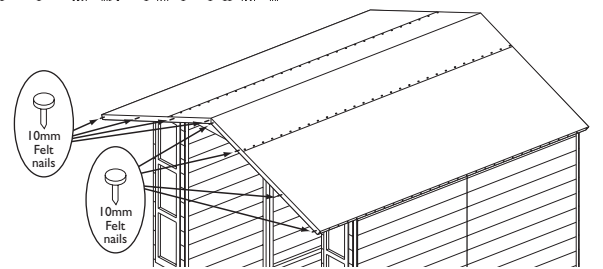
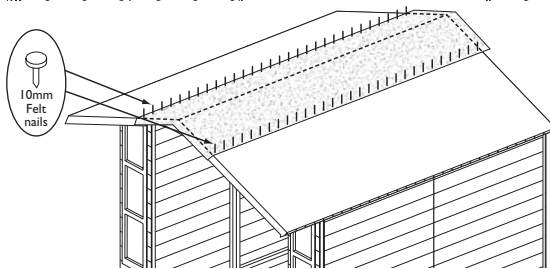
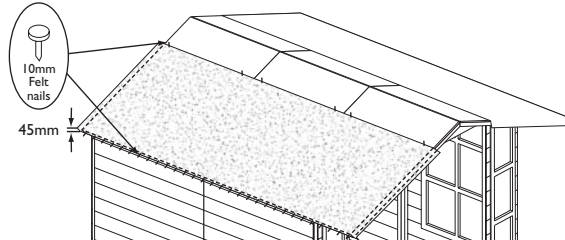
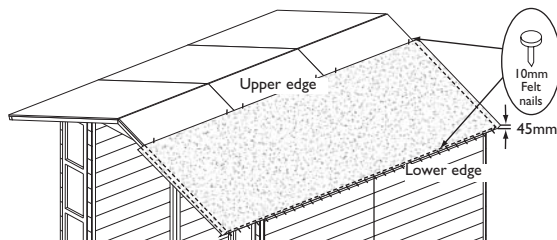

8. Coverstrips, barge boards and finials

Fit a Coverstrips into each corner, attach using 3 x 40mm nails per strip. The remaining 3 are used to cover the panel joints, 1 on each side and the back, attach using 3 x 40mm nails per strip. Attach barge boards at the front so that the top edge is flush with the roof line and the two boards meet evenly in the middle secure using 3 x 40mm nails per board. Repeat for the barge boards on the back. On the front attach a finial centrally over the join between the barge boards use 2 x 40mm nails. Repeat for the finial on the back. Fit the kick strip to the bottom of the door opening using 4 x 40mm nails.

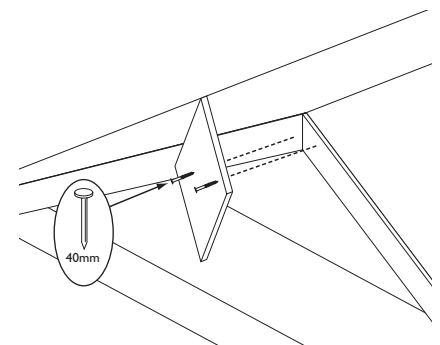
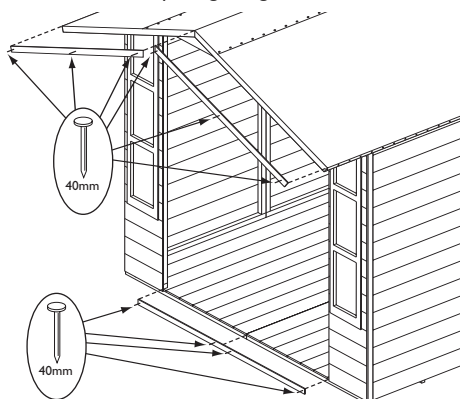
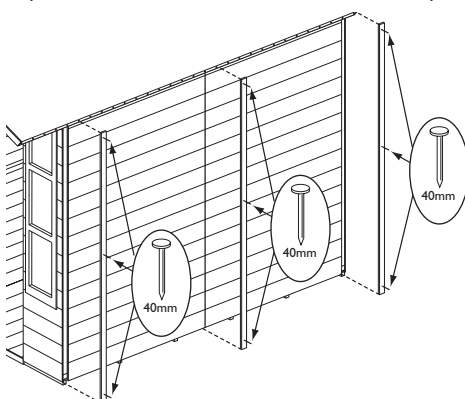

9. Lattice wing panels

Position a lattice wing side panel in the corner of the roof and front panel. ensure the wing is flush to the outer edge of the building and secure using 2 x 50mm screws, screw through the frame of the wing into the front panel, fix to the roof felt batten using 2 x 50mm screws as shown. Attach the other wing panel in the same way.



It is recommended to drill pilot holes for these screws with a 4mm drill bit before assembly.

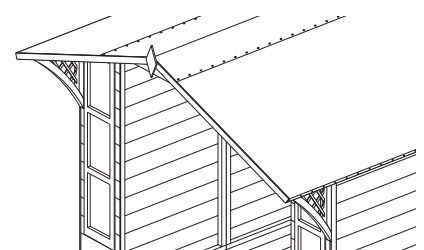
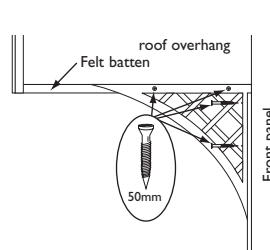
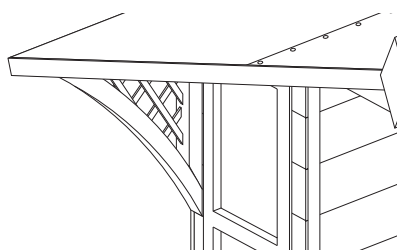

10. Hanging the doors

Fit 3 hinges to a door, along a long edge about 150mm from the ends and 1 in the middle. Fit the hinges into the recess around the edge of the inside of the door attach using 2 x 25mm screws per hinge. Open the hinges and fit them around the door frame, adjust the door to the correct height and fix the hinges to the door frame using 3 x 25mm screws per hinge. Repeat for the other door, fitting the hinges to the opposite door edge. Attach the tower bolts to the inside of the left door as shown using 4 x 19mm round head screws per bolt.

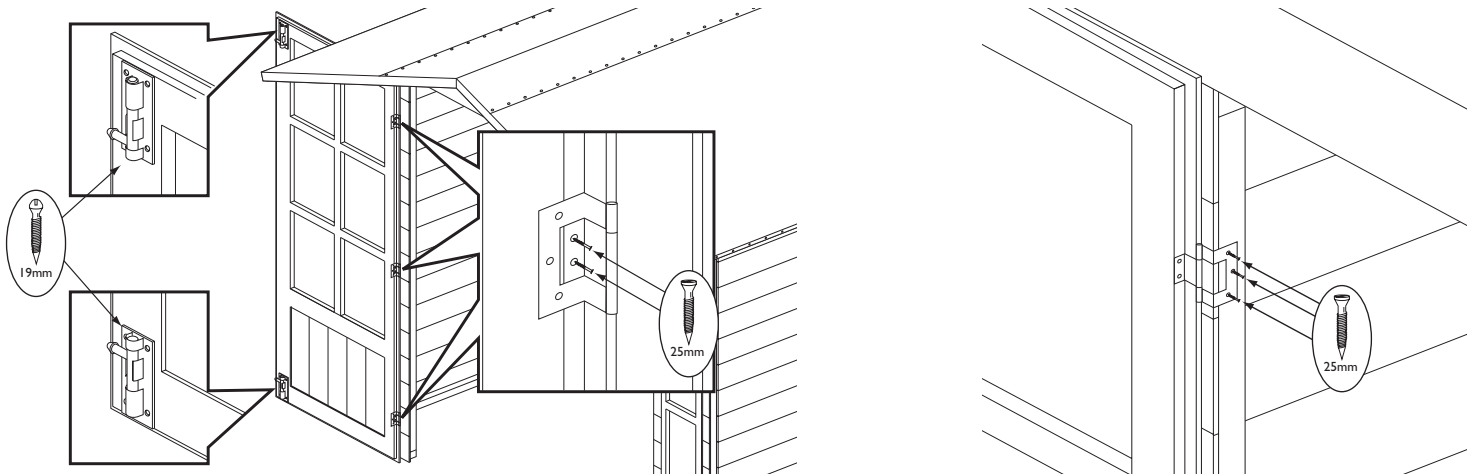

11. Latch door handle

Position the Latch door handle about half way up the door as shown in diagram. Mark the position of the holes on the door. Remove the latch and draw 2 lines connecting opposite corners, drill a 12mm diameter hole where the 2 lines cross. Put the latch bar in the hole on the back of the latch, then reposition the latch (putting the bar through the drilled hole) and attach using 4 x 19mm black screws. On the other side of the door fit the inside door handle to the bar and then using 4 x 19mm black screws attach the handle to the door. On the front of the other door position the latch holder so that it holds the latch horizontal. Once in position attach to the door with 2 x 19mm black screws.

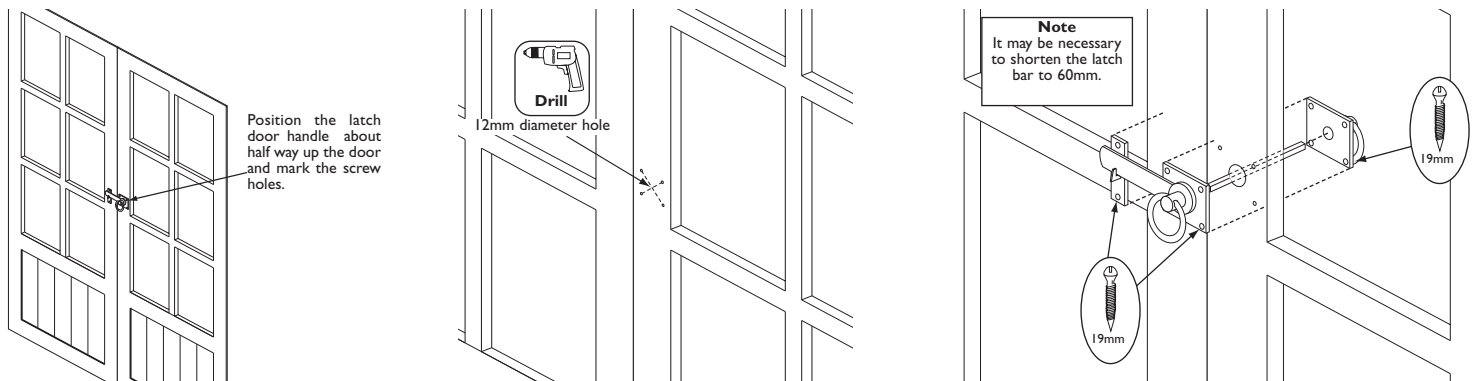

12. Glazing and tower bolt hole

It is recommended that a waterproof sealant is applied around the edge of the glazing before fitting. Place window pane on the inside of the window frame, nail the beading into position using 3 x 25mm nails per strip. Repeat for all the windows and doors. With the doors shut, drop the lower tower bolt and mark where it touches the floor. Drill a 12mm hole in the floor for the bolt to fit in.

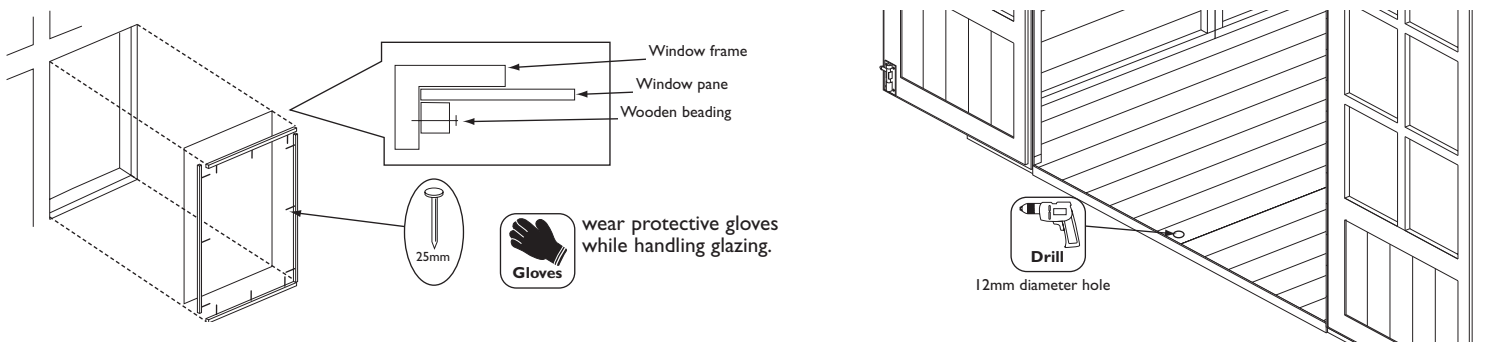

Important information

Shiplap buildings come ready stained but this is only a preparatory treatment. To **VALIDATE** the guarantee, the building must be properly treated with a recognised external wood preserver **WITHIN 3 MONTHS** of assembly and **RE-TREATED ANNUALLY** thereafter. The building must also be erected on 75mm x 50mm treated wooden or similar bearers (These are not supplied with the kit.) Ground contact must be avoided.

Timber Information.

As timber is a natural material, there are certain weather conditions that may affect the materials properties. In times of excessive dry spells the material may lose some of its internal moisture causing a certain degree of shrinkage on a panel and in periods of excessive rain there will be a certain amount of swelling throughout the wooden panels. This process can not be avoided. If you have problems with certain boards shrinking in dry spells try to decrease the amount of direct sunlight on the building or the amount of air passing over the building. During hot spells spray water directly onto the panels with the aid of a garden hose.

If in doubt of any aspect regarding the assembly, use or safety of your building please contact us :

Help Line (Normal Office Hours) 01829 261 121

ROWLINSON GARDEN PRODUCTS LIMITED
Green Lane
Wardle Nr.Nantwich
Cheshire
CW5 6BN
Tel : 01829 262080
Fax : 01829 262089

We constantly improve the quality of our products, occasionally the components may differ from the components shown and are only correct at time of printing. We reserve the right to change the specification of our products without prior notice.

2006 © Rowlinson Garden Products Ltd