

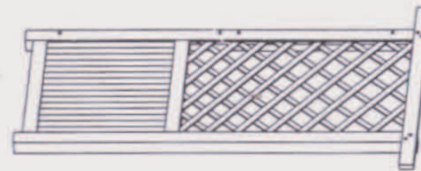

Assembly Instructions



A x 2
Left - Right



D x 1

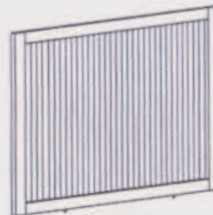

B x 1

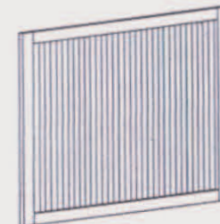

C x 1



E x 4
Left - Right



F x 2
Front - Back

LIST OF HARDWARE

No.	Hardware	Qty.
1	Vis (7x90)mm	8
2	Vis (7x70)mm	4
3	Vis (7x60)mm	6
4	Vis (7x50)mm	4
5	Vis (4x40)mm	16
6		2

G x 2
Left - Right



H x 1



We constantly improve the quality of our products, occasionally the components may differ from the components shown and are only correct at time of printing. We reserve the right to change the specification of our products without prior notice.

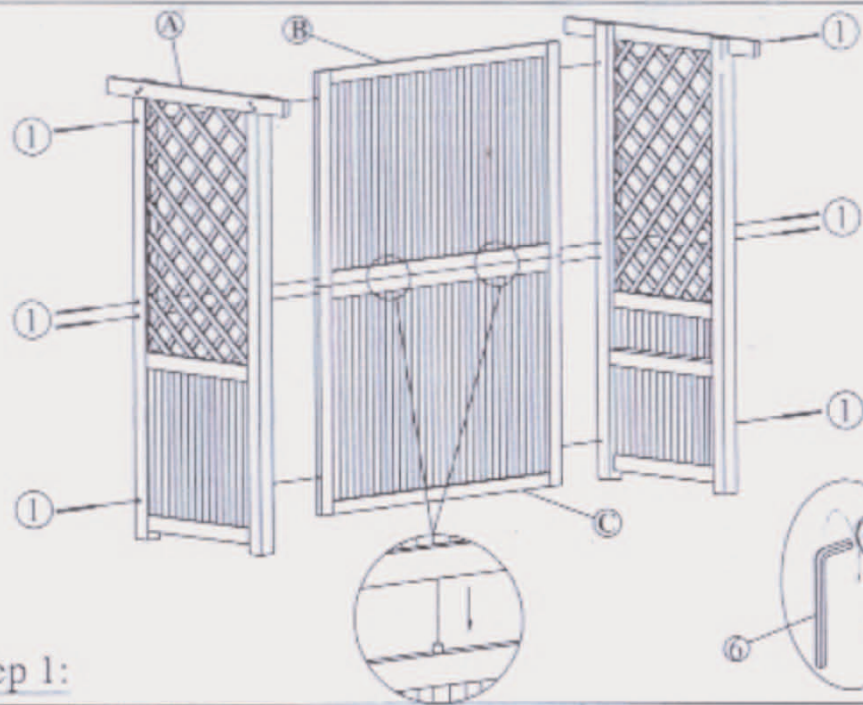

Step 1:

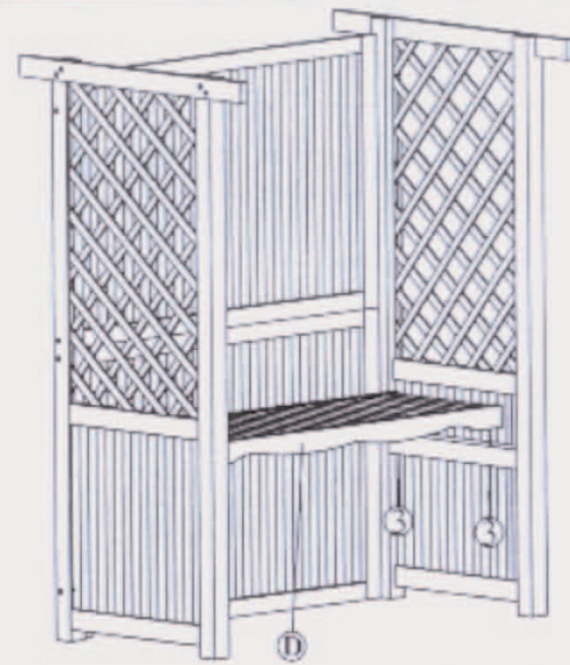

Step 2:

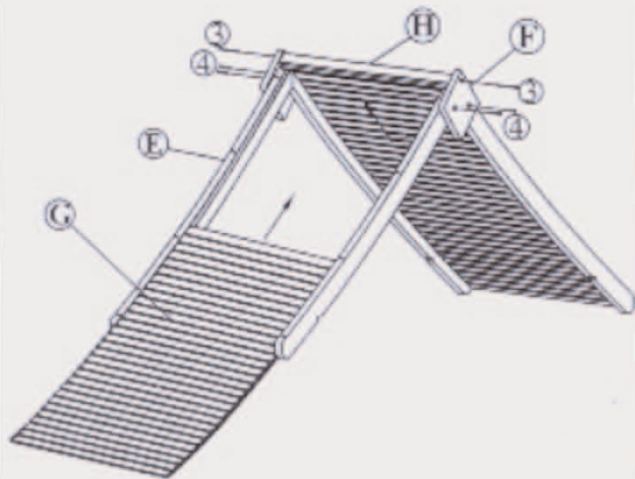

Step 3:

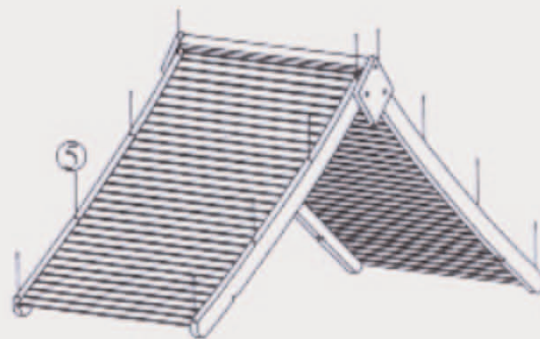

Step 4:



Step 5: