



TRADITIONAL PERGOLA

ALL PRODUCTS ARE MEASURED TO THE HIGHEST AND WIDEST POINT AND ALL SIZES ARE APPROXIMATE

PLAN

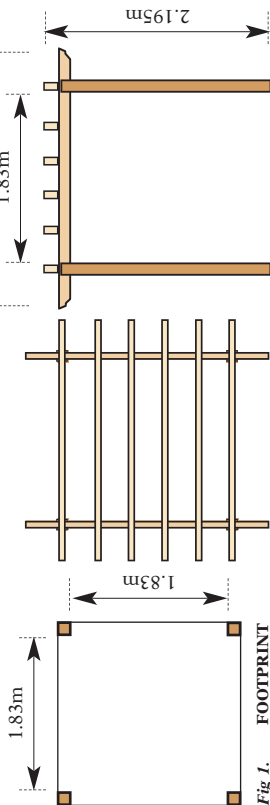
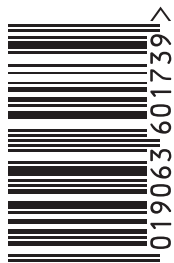

Fig 1. FOOTPRINT

PLEASE SEE OVERLEAF FOR ASSEMBLY INSTRUCTIONS
NB. These instructions describe the concrete-in method of fixing using 2.7m posts. Bolt Down Anchors or Spikes may be used with 2.1m posts as alternative methods of fixing.



Grange Code: PKTRADA



GRANGE FENCING LIMITED
Halesfield 21, Telford TF7 4PA
Tel: 01952 588088 Fax: 01952 581522
Email: sales@grangefen.co.uk Web: www.grangefen.co.uk
OUT OF HOURS MESSAGE SERVICE: 01952 588088

JULY 2011 - ISSUE 2

TRADITIONAL PERGOLA (PKTRADA)





TRADITIONAL PERGOLA ASSEMBLY INSTRUCTIONS

PARTS SUPPLIED



Ref.	Description	Qty.
A	POSTS (ATPOST9)	4
B	RAFTERS	8
C	'U' CLIPS	12

TOOLS REQUIRED *(not supplied)*

CROSS HEAD SCREWDRIVER

BEFORE YOU START

- Check the pack/s and make sure that you have all of the parts listed above. If not, contact your retailer who will be able to help you.
- When you are ready to start, make sure you have the right tools to hand, plenty of space and a clean, dry area for assembly.
- It is advisable for two people to carry out the work.

1x HARDWARE PACK & ACCESSORIES:			
x	SCREWS 5 x 70mm		8
y	SCREWS 4 x 40mm		48

SITE PREPARATION

Mark out the area where the structure is to be sited using the 'footprint' shown overleaf.

Excavate a 300mm² hole for each post to a depth of at least 300mm (see Fig.A).

We would recommend that you use **MetCrete**, fast set post fixing concrete to fix your posts. Easy to use, it sets in just 10 minutes.

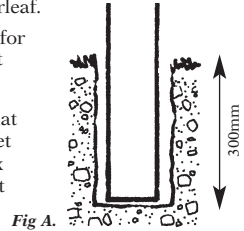

ASSEMBLY

1. The Structure is spaced to allow standard Grange panels to be inserted, if preferred, to provide a screen. The distance between each of the posts is therefore 1830mm (see Fig.1).
2. It is advisable to mark each of the Rafters (B), used as supports, where the roof rafters will be fixed, before beginning assembly. For the suggested spacing see Fig.2.
3. Decide on the orientation of the structure.
4. Position two of the Posts (A) to enable one of the Rafters, previously marked, to be fitted. Ensure the distance between the two Posts is set at 1830mm before fixing the rafter in position with screws (x).
5. Repeat step 4 for the second pair of Posts.
6. Using one of the remaining Rafters, fix it at one of the end points on one of the assemblies, using the 'U' Clips (C) as Fig.3.
7. Then fix the other end of the Rafter to the other assembly at the corresponding point.
8. Repeat steps 6 & 7 at the opposite end of the structure so that it is able to stand upright. Ensure it is level and upright by adjusting posts.
9. When this has been carried out, the remaining Rafters may be fixed using the 'U' Clips at the positions previously marked.
10. Re-check that the structure is level and upright. (see Fig.4) before fixing the posts permanently.

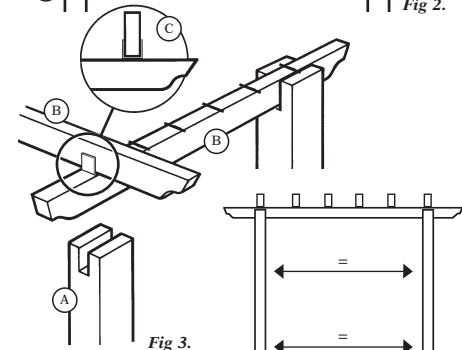
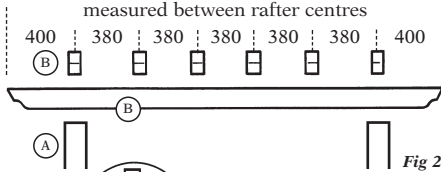

Fig 3.

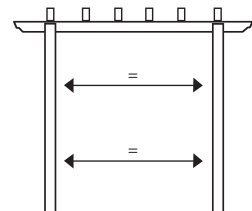

Fig 4.

AFTERCARE

To ensure longevity of your structure it is recommended that it is treated with a wood preservative on a yearly basis.